

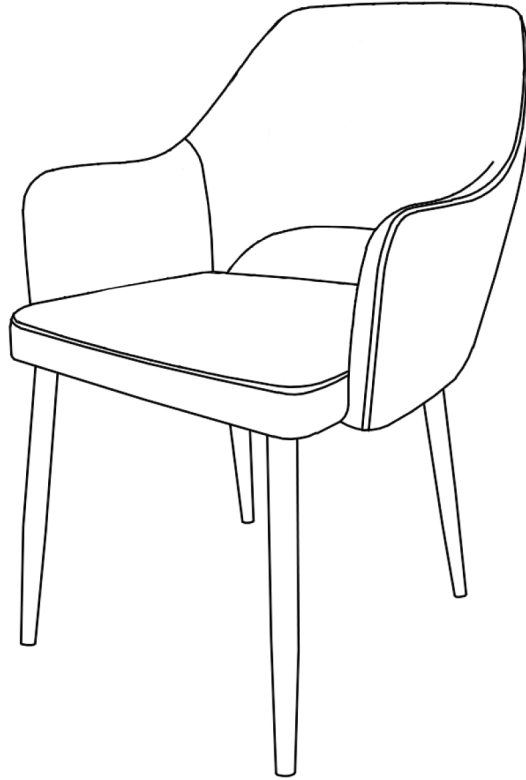

— Thank you for buying the Clara Dining Chair



**Before you start:**

**Unpack carefully**

- Avoid using sharp objects that might cause damage
- Be careful not to dispose of the enclosed assembly kit
- Please dispose of the packaging responsibly

**Before and during assembly**

- Make sure all items are accounted for and clearly laid out before starting
- Make sure you have enough space to assemble the chair safely
- Place the parts on a soft and flat surface to avoid damage
- Put all bolts in before fully tightening
- Do not use power tools or overtighten any fittings as this can cause damage
- Carefully trim off any loose threads on upholstered chairs

**Caution**

- This chair is designed to seat one person only
- Do not stand or jump on this chair
- Do not rock on this chair, or lean back with only two legs on the ground
- Do not use this chair unless all the bolts and screws are firmly tightened
- Keep small parts, plastic bags and film away from children



— In the box

**A** x 1

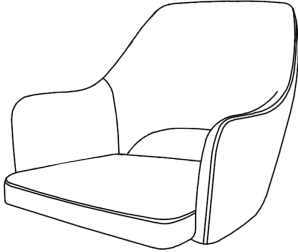

Seat

**B** x 1

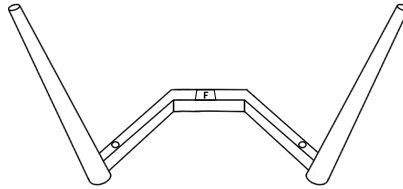

Front Legs

**C** x 1

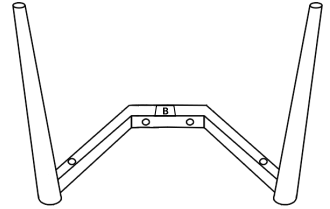

Back Legs

**D** x 6

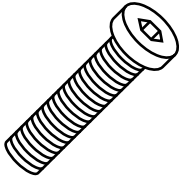

Bolt M6x40mm

**E** x 6

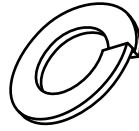

Spring Washer 13mm

**F** x 6

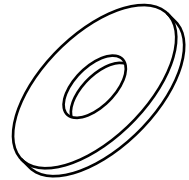

Flat Washer 16mm

**G** x 1



Allen Key 5mm



- 1 Join the front and back legs using the bolts and washers as shown, but do not fully tighten the bolts.

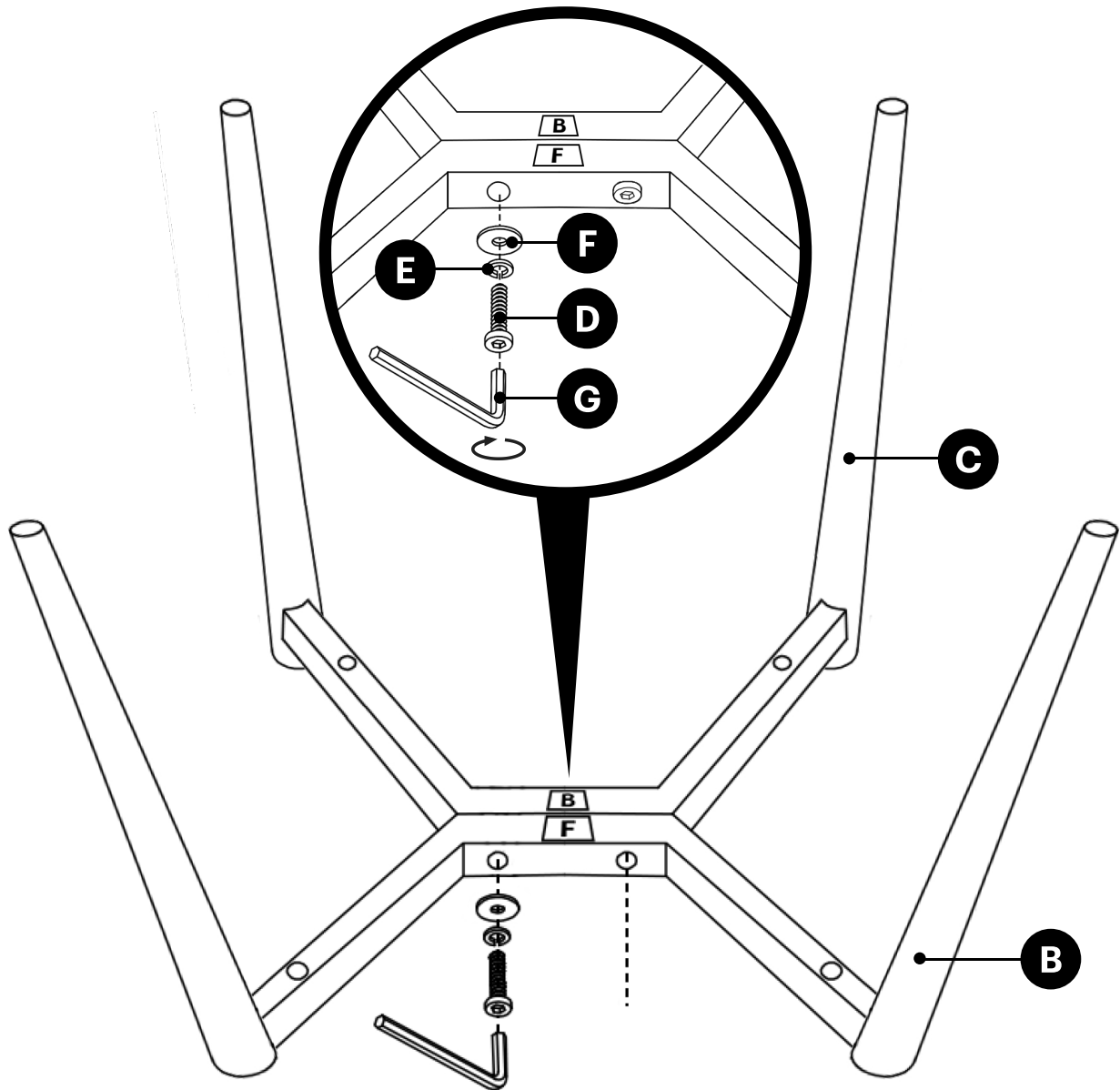



- 2** Attach the legs to the seat using the bolts and washers as shown and tighten with the Allen key. Then fully tighten the bolts from Step 1.

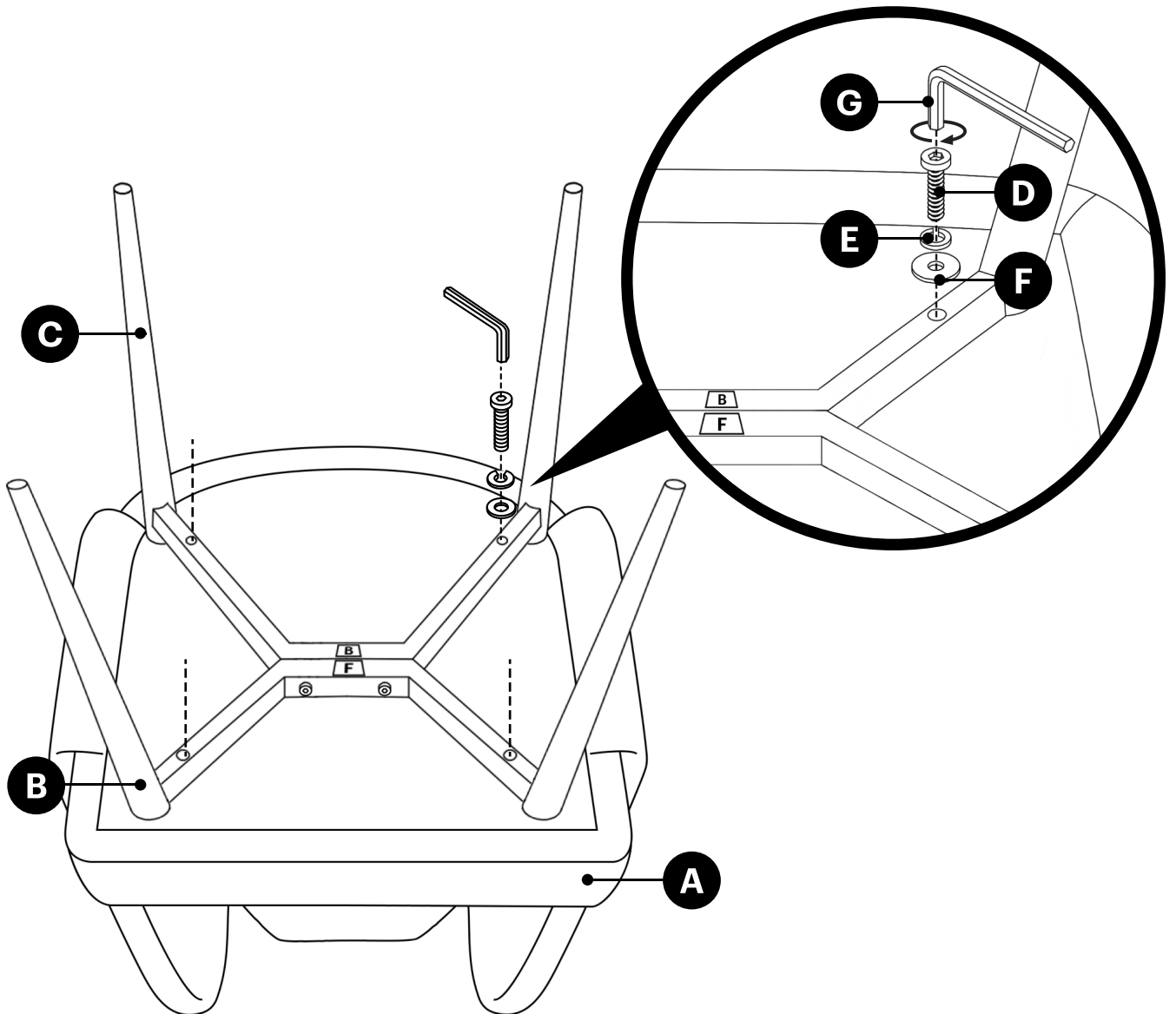



**3**

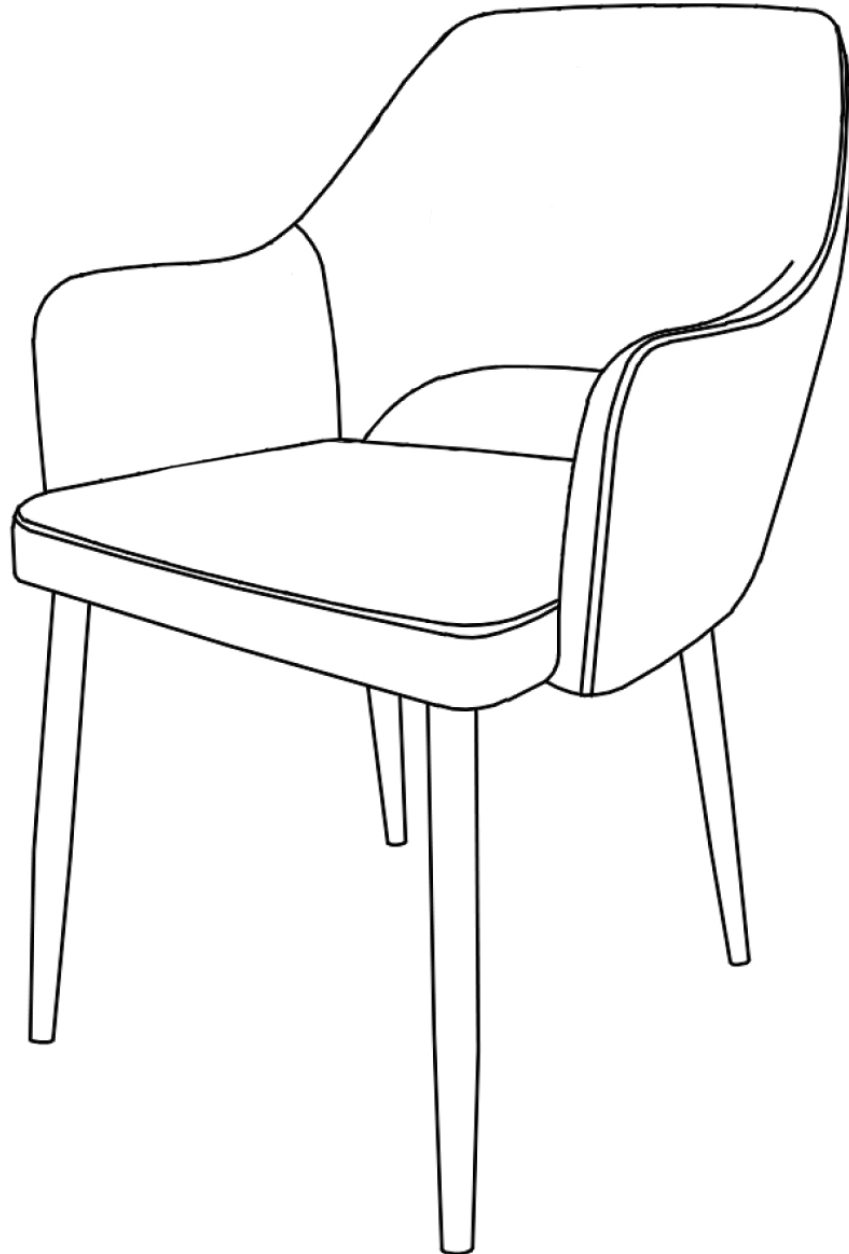

**— Important information - please read before use****Upholstery and appearance**

- Every effort has been made to ensure each piece of furniture matches
- Upholstery can have a pile in the weave and look different from various angles and lighting – this is a characteristic of the material and not a fault
- Upholstery can have slight variations in colour and finish
- Wood will have natural variation in the colour and grain – this is a characteristic of the material and not a fault

**Cleaning your furniture**

- Do not use household cleaning products, bleaches, solvent based cleaners, detergents, corrosives, scourers or abrasives, which can damage surfaces and upholstery
- Dust and vacuum your furniture on a weekly basis with the appropriate upholstery attachment
- Use a clean, soft, lint-free cloth slightly dampened with water to remove dirt or body oils
- For tougher stains, use a soft cloth with a little non-alkaline, non-detergent soap

**Caring for your furniture**

- Remove spills immediately – do not rub stains and spills, blot them first
- Avoid placing damp clothing, wet towels or printed newspapers directly on the upholstery
- Avoid strong sunlight (such as through patio doors and windows), as this can cause discolouration, fading or surface degradation over time
- Avoid strong sunlight on chrome finishes as this can magnify the heat of the sun
- Avoid sharp objects such as studs, buckles, jewellery, heels, toys or a pet's claws on the upholstery as this can cause damage
- Greasy and oily hair products can damage upholstery
- Light-coloured upholstery can be at risk of discolouration due to dye transfer from dark or strong-coloured clothing, cushions and throws

**To avoid structural damage**

- Regularly tighten the bolts to avoid damage and maintain stability and strength

This chair is for indoor, residential use only.

For more information and support, visit [help.furniturechoice.co.uk](http://help.furniturechoice.co.uk)