

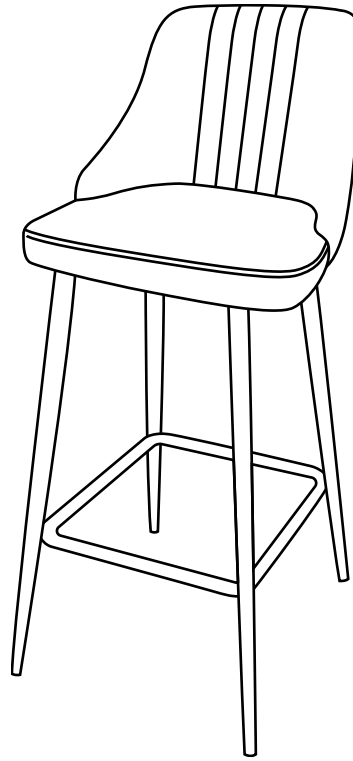

— Thank you for buying the Lisbon Bar Stool



Before you start:

Unpack carefully

- Avoid using sharp objects that might cause damage
- Be careful not to dispose of the enclosed assembly kit
- Please dispose of the packaging responsibly

Before and during assembly

- Make sure all items are accounted for and clearly laid out before starting
- Make sure you have enough space to assemble the bar stool safely
- Place the parts on a soft and flat surface to avoid damage
- Put all bolts in before fully tightening
- Do not use power tools or overtighten any fittings as this can cause damage
- Carefully trim off any loose threads on upholstered bar stools

Caution

- This bar stool is designed to seat one person only
- Do not stand or jump on this bar stool
- Do not rock on this bar stool, or lean back with only two legs on the ground
- Do not use this bar stool unless all the bolts and screws are firmly tightened
- Keep small parts, plastic bags and film away from children



— In the box

A x 1

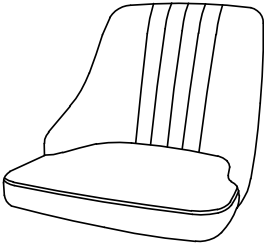

Seat

B x 1

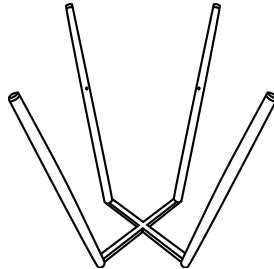

Legs

C x 1

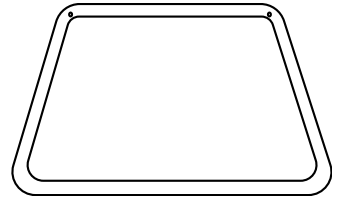

Footrest

D x 4

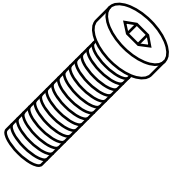

Bolt M6x25mm

E x 4

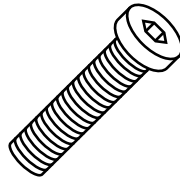

Bolt M6x40mm

F x 4

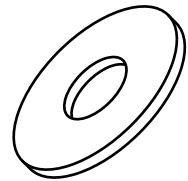

Flat Washer 16mm

G x 1



Allen Key 5mm



- 1 Attach the legs to the seat as shown, but do not fully tighten the bolts.

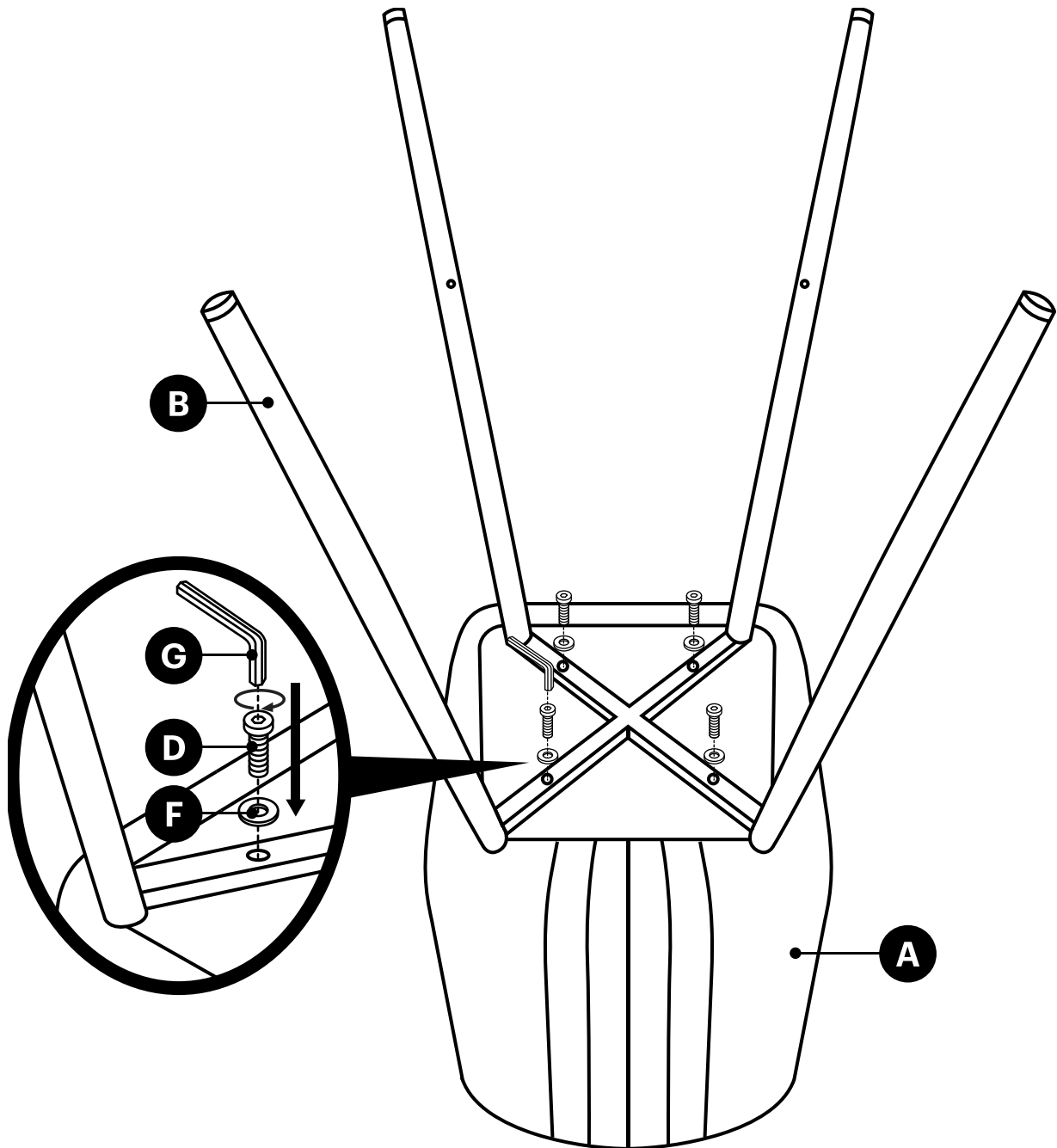



2 Attach the footrest to the legs as shown, **but do not fully tighten the bolts.**

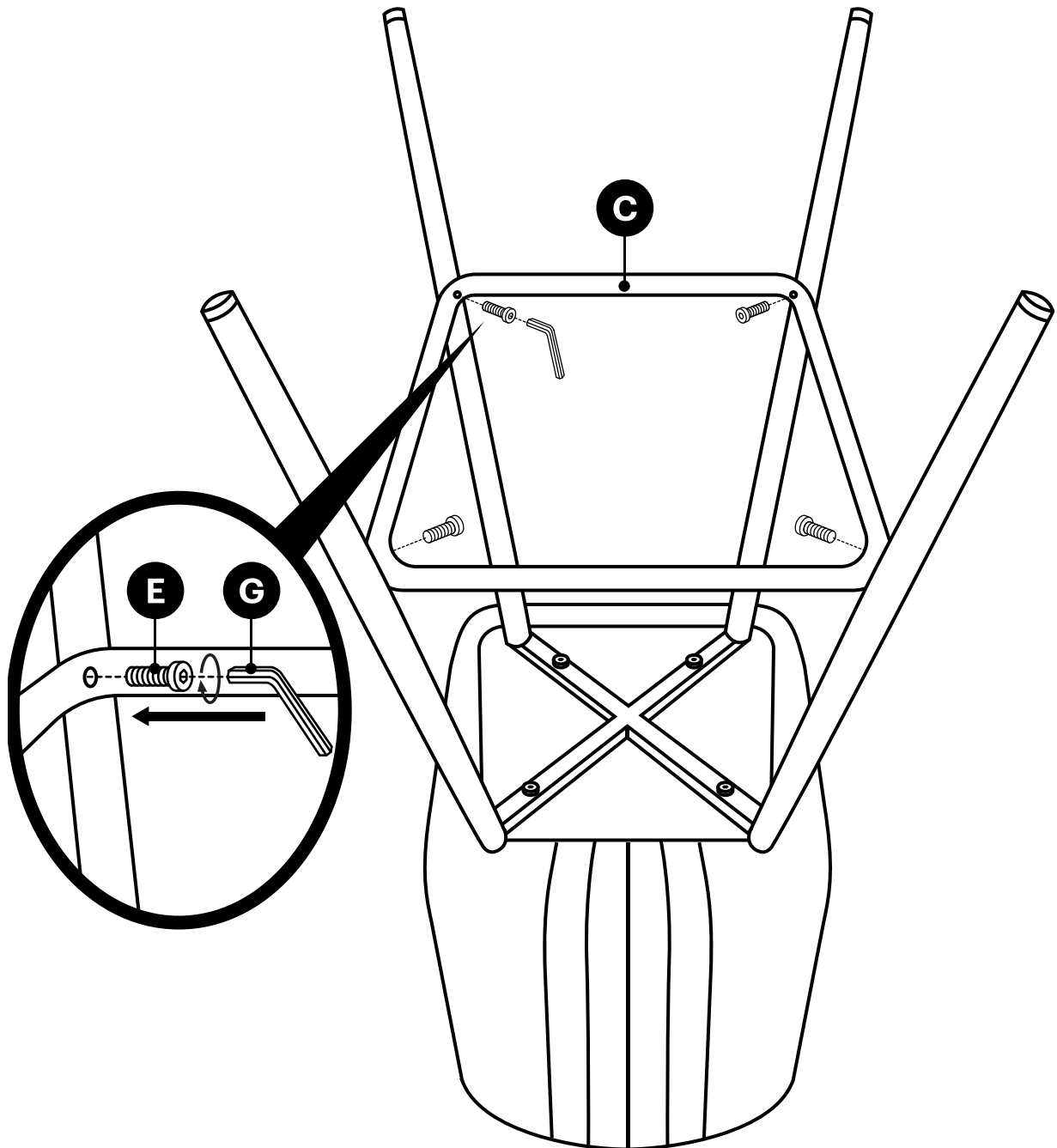



- 3** Place the bar stool upright on a flat surface. Hold the bar stool and move the seat from side to side until the legs are level. Then fully tighten all bolts.

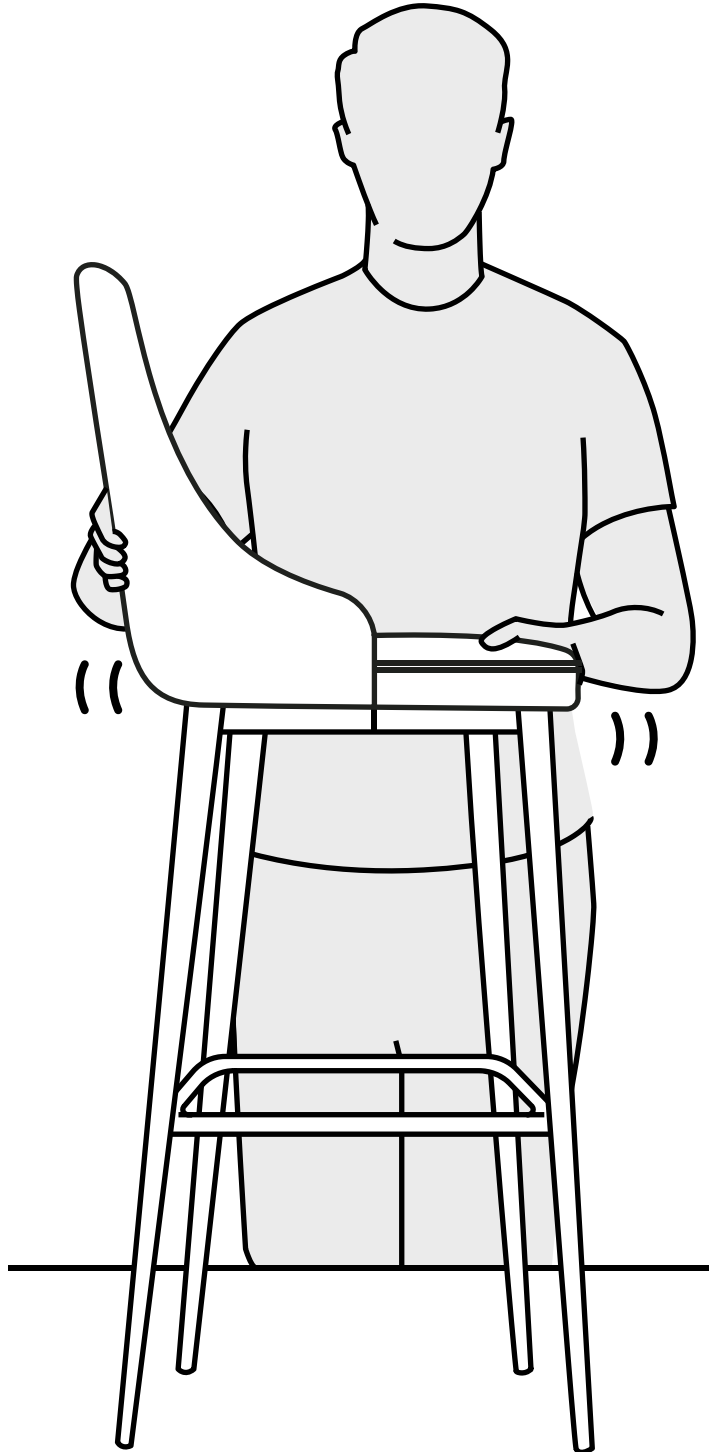



4

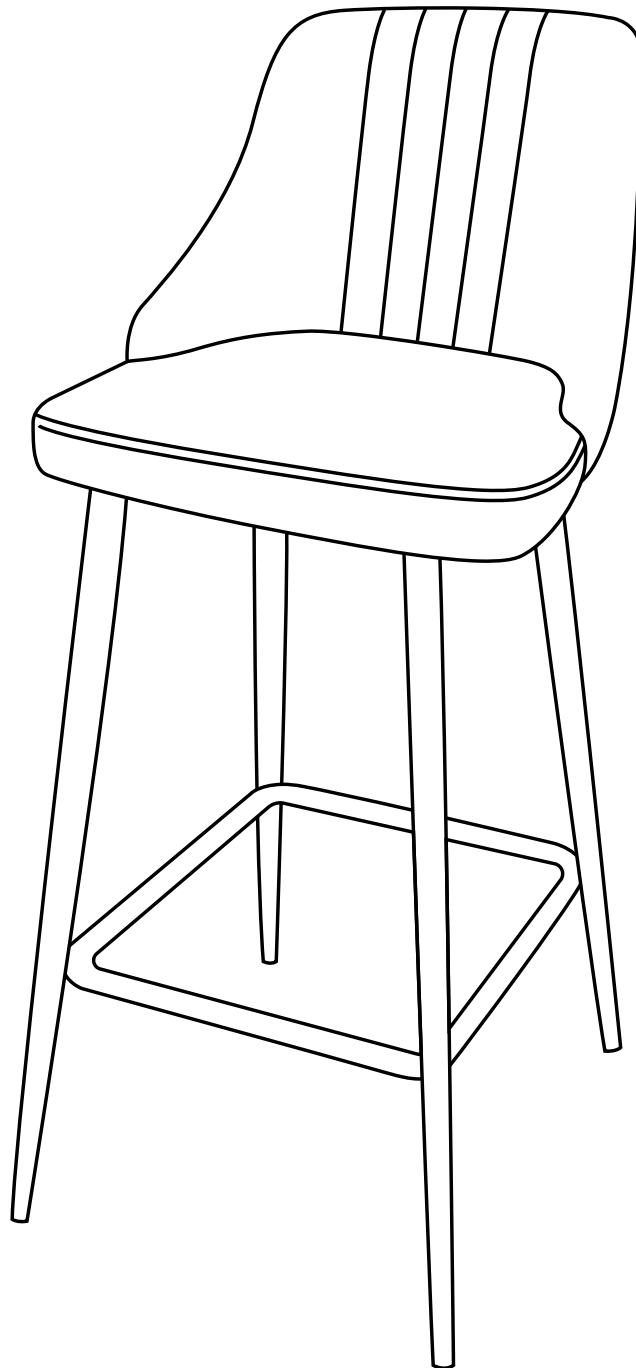



— **Important information - please read before use**



Upholstery and appearance

- Every effort has been made to ensure each piece of furniture matches
- Upholstery can have a pile in the weave and look different from various angles and lighting – this is a characteristic of the material and not a fault
- Upholstery can have slight variations in colour and finish
- Wood will have natural variation in the colour and grain

Cleaning your furniture

- Do not use household cleaning products, bleaches, solvent based cleaners, detergents, corrosives, scourers or abrasives, which can damage surfaces and upholstery
- Wipe clean with a damp cloth and dry with a soft duster making sure no surfaces are left wet
- For tougher stains, use a soft cloth with a little non-alkaline, non-detergent soap
- Dust and vacuum your furniture on a weekly basis with the appropriate upholstery attachment

Caring for your furniture

- Remove spills immediately – do not rub stains and spills, blot them first
- Avoid strong sunlight (such as through patio doors and windows), as this can cause discolouration, fading or surface degradation over time
- Avoid strong sunlight on chrome finishes as this can magnify the heat of the sun
- Avoid sharp objects such as studs, buckles, jewellery, heels, toys or a pet's claws on the upholstery as this can cause damage
- Greasy and oily hair products can damage upholstery
- Light-coloured upholstery can be at risk of discolouration due to dye transfer from dark or strong-coloured clothing, cushions and throws
- Avoid placing damp clothing, wet towels or printed newspapers directly on the upholstery

To avoid structural damage

- Regularly tighten the bolts to avoid damage and maintain stability and strength

This bar stool is for indoor, residential use only.

For more information and support, visit help.furniturechoice.co.uk