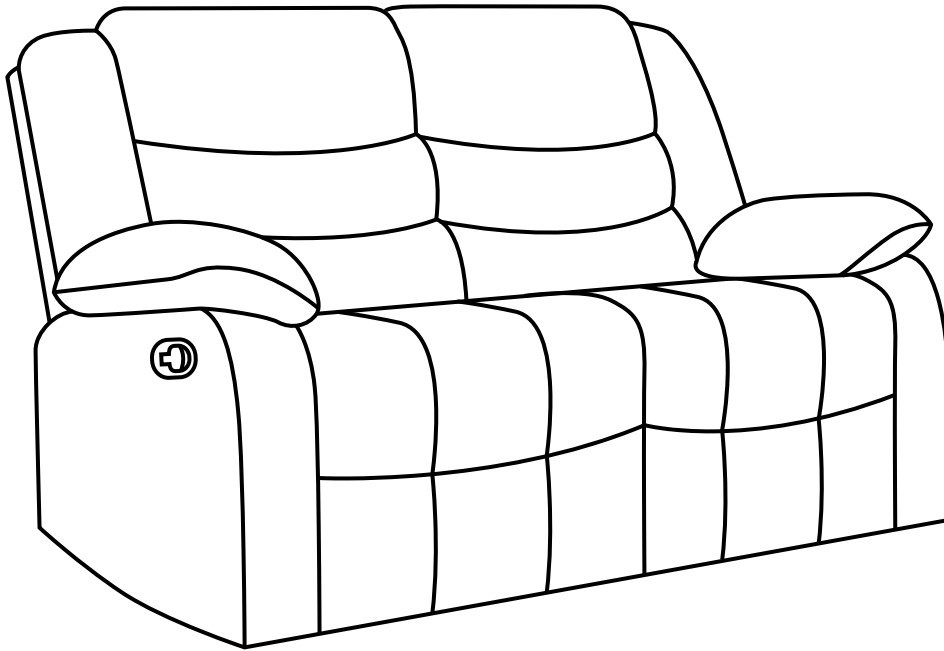

**— Thank you for buying the Sorrento 2 Seater Recliner Sofa****Before you start:****Unpack carefully**

- Avoid using sharp objects that might cause damage
- Be careful not to dispose of the enclosed assembly kit
- Please dispose of the packaging responsibly

Before and during assembly

- This sofa requires 2 people to assemble
- Make sure all items are accounted for and clearly laid out before starting
- Make sure you have enough space to assemble the sofa safely
- Assemble the sofa where it will be placed to avoid moving unnecessarily
- Place the parts on a soft and flat surface to avoid damage
- Make sure backrests are slotted in evenly and not at an angle
- Do not use power tools or overtighten any fittings as this can cause damage
- If the upholstery is creased, plump the cushions and allow the sofa to settle at room temperature
- Carefully trim off any loose threads

Caution

- Do not stand or jump on the sofa
- Keep small parts, plastic bags and film away from children



— In the box

A x 1

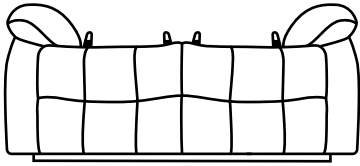

Sofa Frame

B x 1

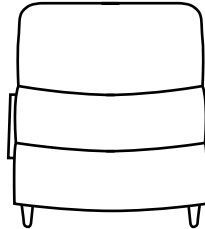

Left Backrest

C x 1

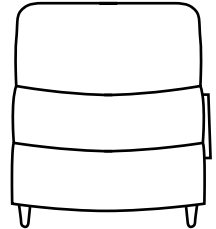

Right Backrest

D x 1

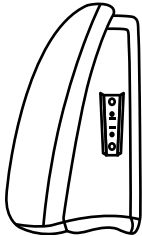

Left Shoulder

E x 1

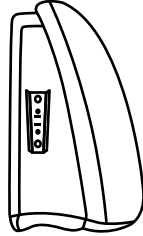

Right Shoulder



- 1 Make sure the backrests are aligned to the brackets, then push down evenly and firmly until they click into place.

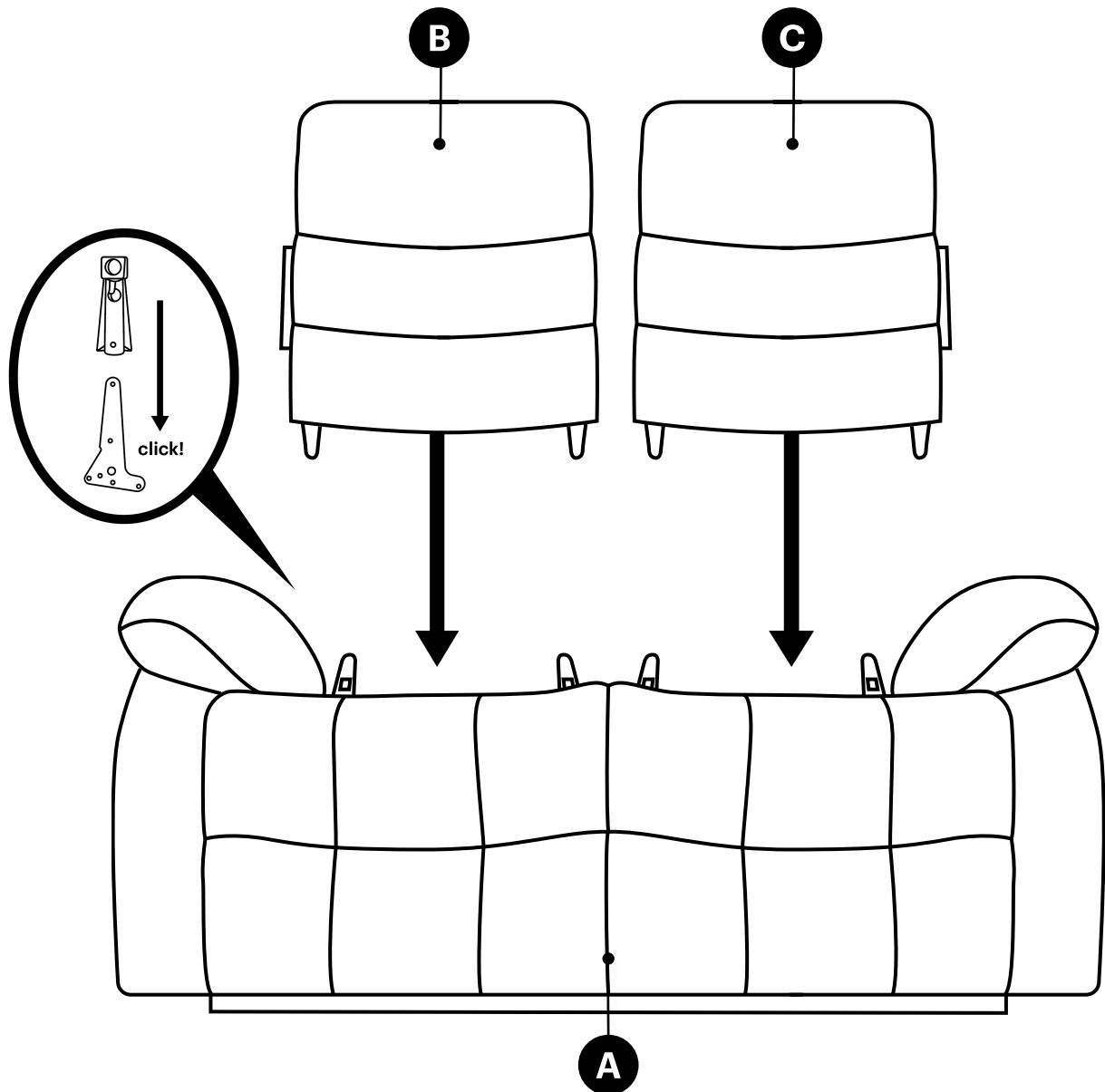



2 Aligning the backrests

If the backrests are not aligned, check that they have 'clicked' into place. Otherwise, detach the backrests and repeat the process.

Align the cushion stitching by firmly rubbing your hand up and down the backrests.

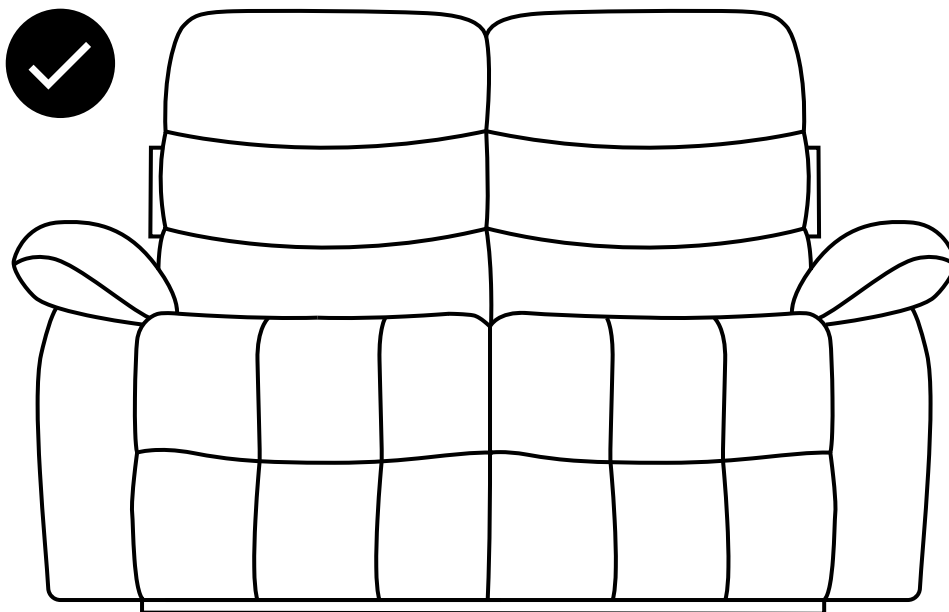
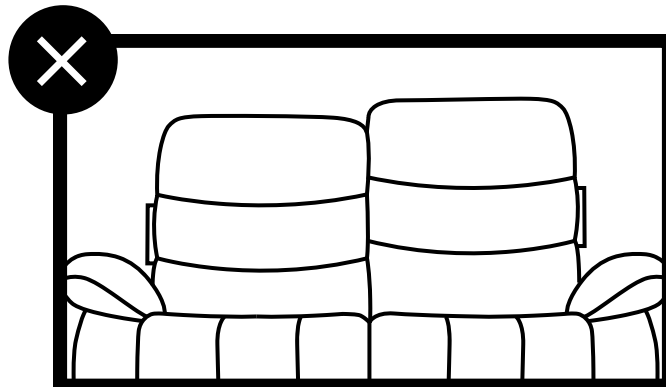

Troubleshooting

If your recliner is misaligned, check out our troubleshooting video.



3 Attach the backrest covers to the base of the sofa with the velcro as shown.

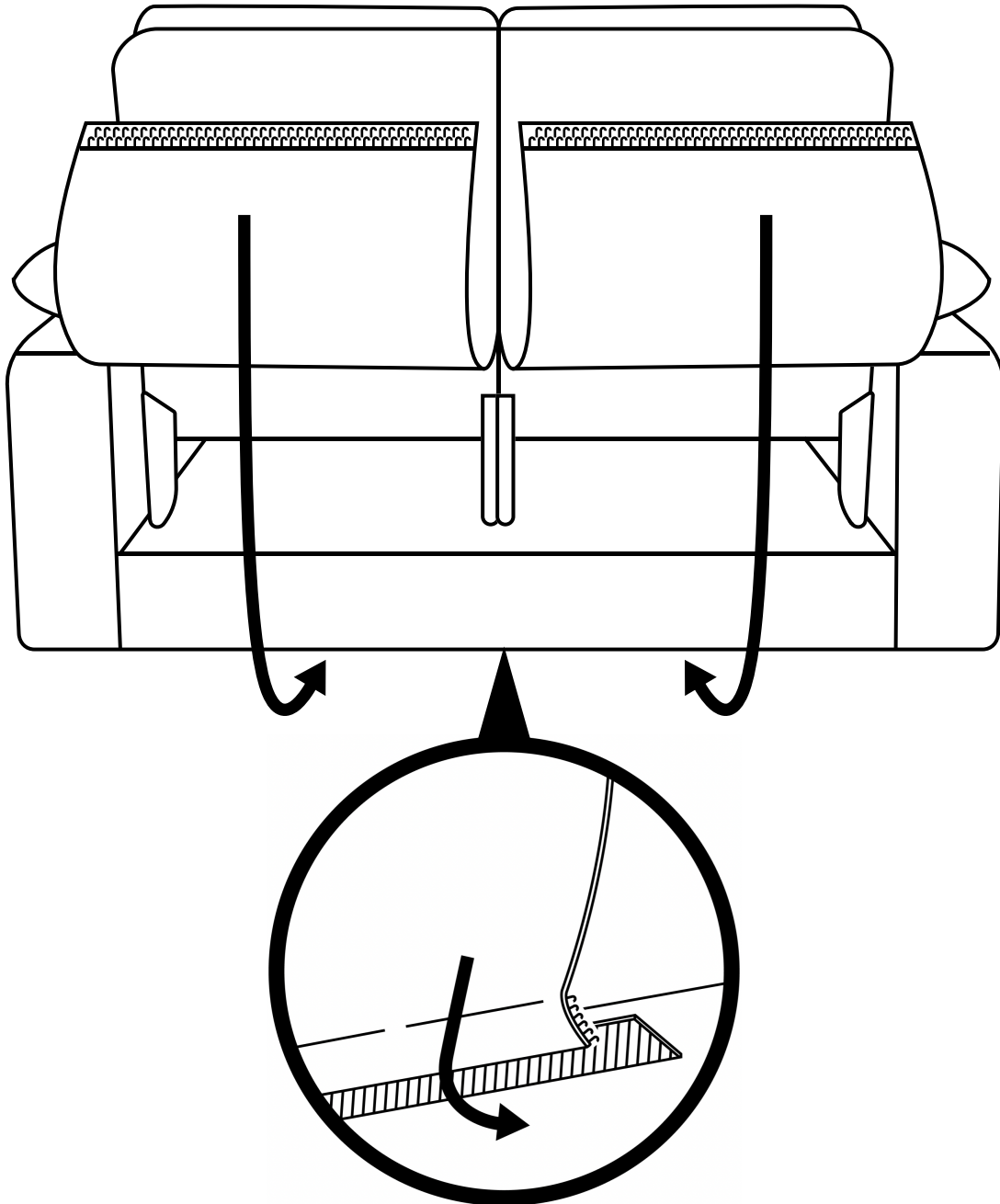



4 Connect the shoulders by slotting them into the brackets.

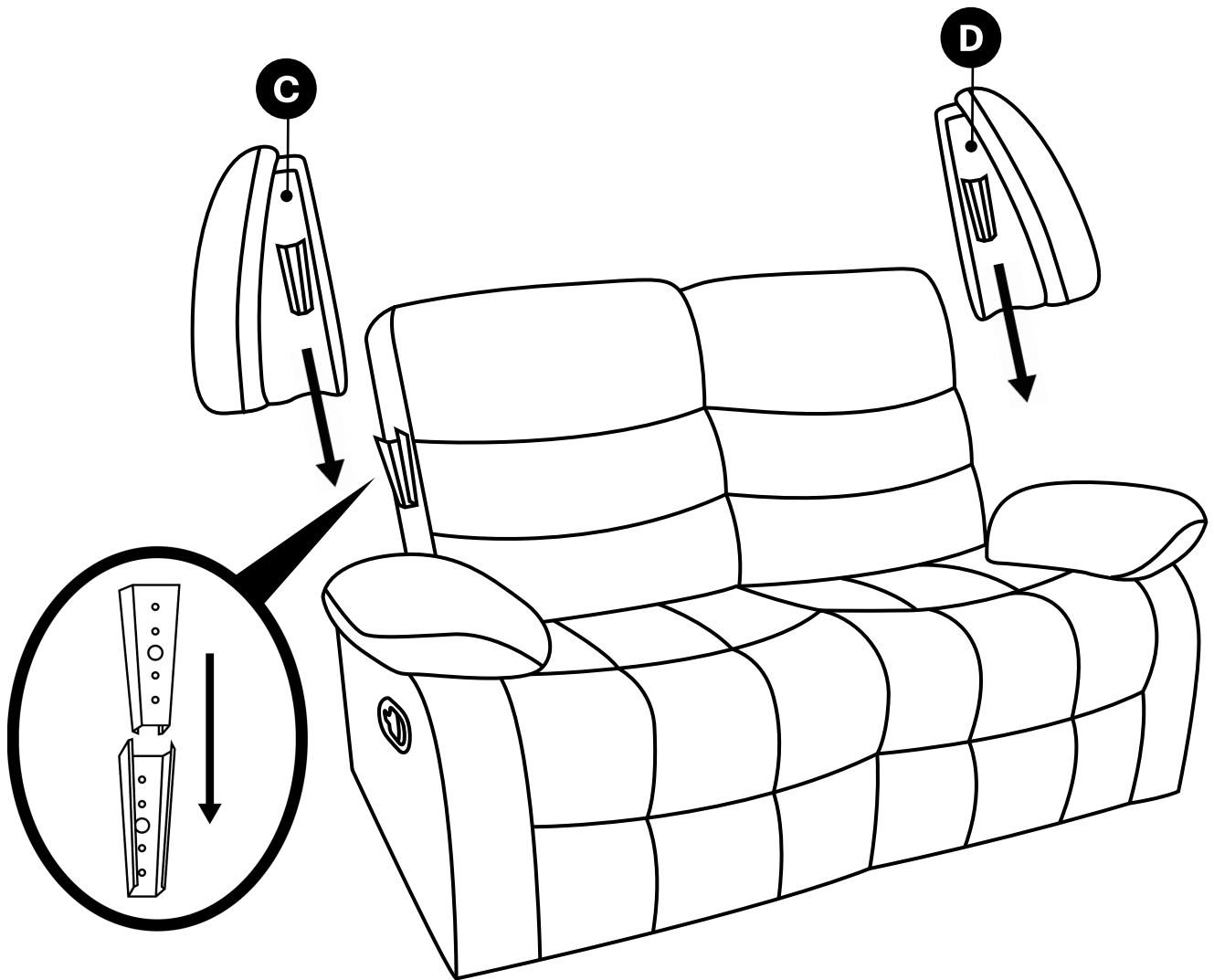



5 Pat and plump the surfaces to reshape and align the cushions as necessary.

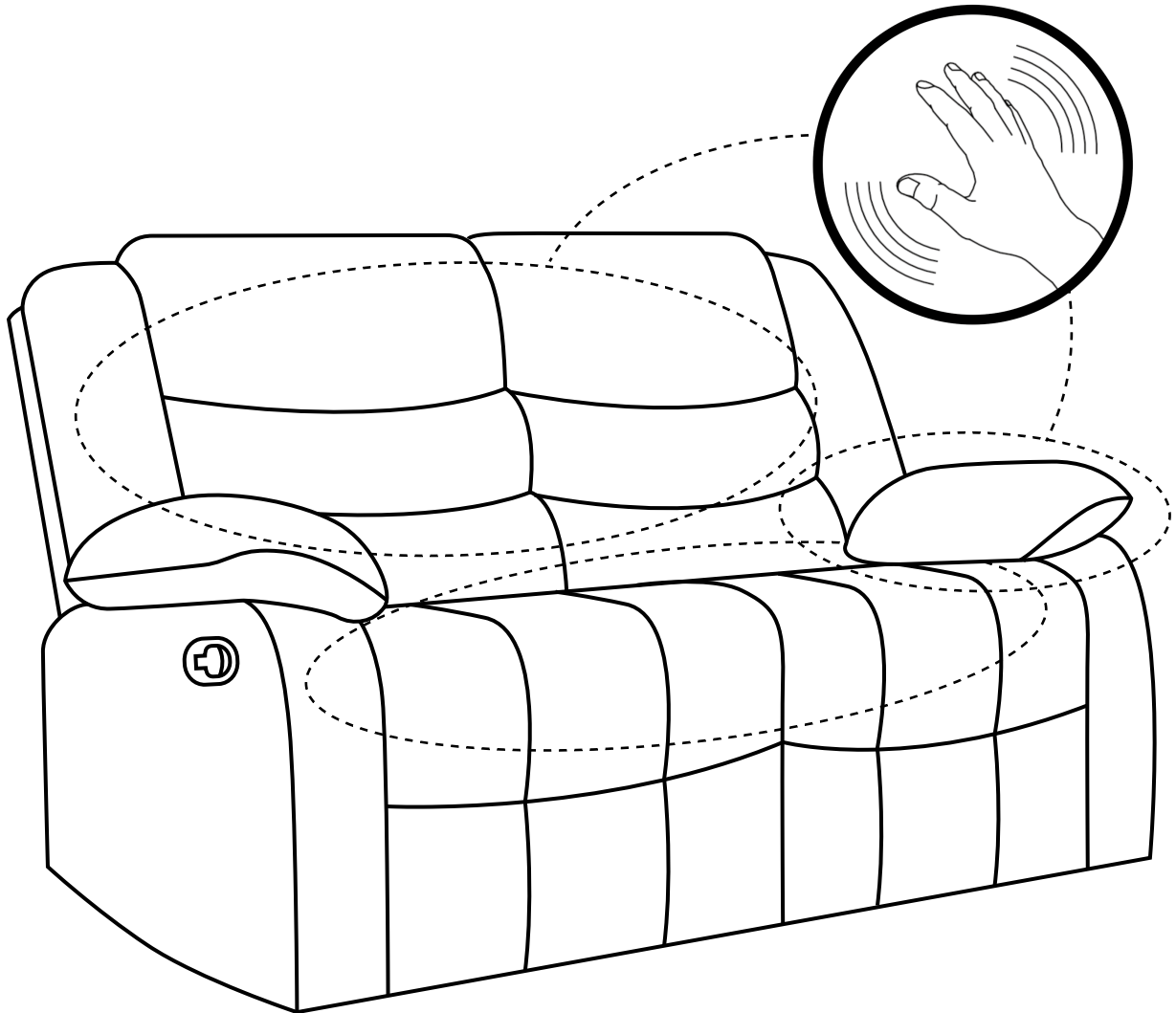



6

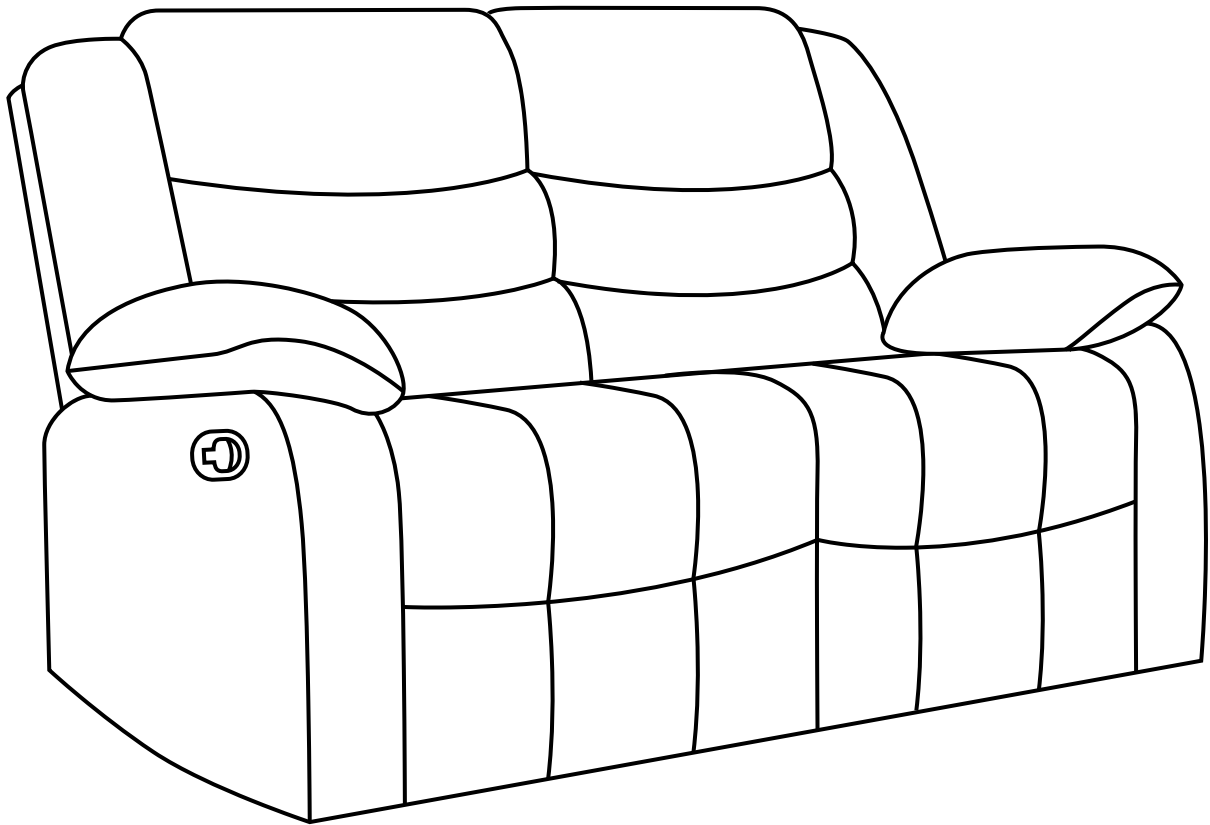

How to recline your sofa

- The handle is located on the side of the sofa
- Simply pull the handle to release the footrest
- Then lean on the backrest until you achieve your desired position
- To return to the original position, push down firmly on the footrest until it clicks into place



— **Important information - please read before use**



Upholstery and appearance

- Every effort has been made to ensure each piece of furniture matches
- Upholstery can have a pile in the weave and look different from various angles and lighting – this is a characteristic of the material and not a fault
- Upholstery can have slight variations in colour and finish
- Creasing in seats and back cushions may appear over time and is a natural characteristic of the material

Cleaning your furniture

- Do not use household cleaning products, bleaches, solvent based cleaners, detergents, corrosives, scourers or abrasives, which can damage surfaces and upholstery
- Dust and vacuum your furniture on a weekly basis with the appropriate upholstery attachment
- Use a clean, soft, lint-free cloth slightly dampened with water to remove dirt or body oils
- For tougher stains, use a soft cloth with a little non-alkaline, non-detergent soap

Caring for your furniture

- Remove spills immediately – do not rub stains and spills, blot them first
- Avoid placing damp clothing, wet towels or printed newspapers directly on the upholstery
- Avoid placing hot cups or plates directly onto the furniture as this can damage the upholstery
- Avoid strong sunlight (such as through patio doors and windows), as this can cause discolouration, fading or surface degradation over time
- Avoid strong sunlight on chrome finishes as this can magnify the heat of the sun
- Avoid sitting on the edge of the cushions as this can cause distortion or permanent wear
- Do not sit on the arms
- Avoid sharp objects such as studs, buckles, jewellery, heels, toys or a pet's claws on the upholstery as this can cause damage
- Greasy and oily hair products can damage upholstery
- Light-coloured upholstery can be at risk of discolouration due to dye transfer from dark or strong-coloured clothing, cushions and throws

Safety notes for recliners

- Ensure the footrest is returned correctly and the mechanism clicks back into place
- Do not put fingers down the side of the mechanism
- Do not sit on the footrest

To avoid structural damage

- Regularly tighten the bolts to avoid damage and maintain stability and strength

This sofa is for indoor, residential use only.

For more information and support, visit help.furniturechoice.co.uk